



MAILBOX COLLECTIONS



The Leading Manufacturer of Custom Mailboxes & Signage in the Southeastern United States

877-818-7180 • sales@creativesigndesigns.com • creativemailboxdesigns.com

TAMPA
12801 Commodity Place
Suite 200
Tampa, FL 33626

ORLANDO
830 S. Ronald Regan Blvd.
#232
Longwood, FL 32750

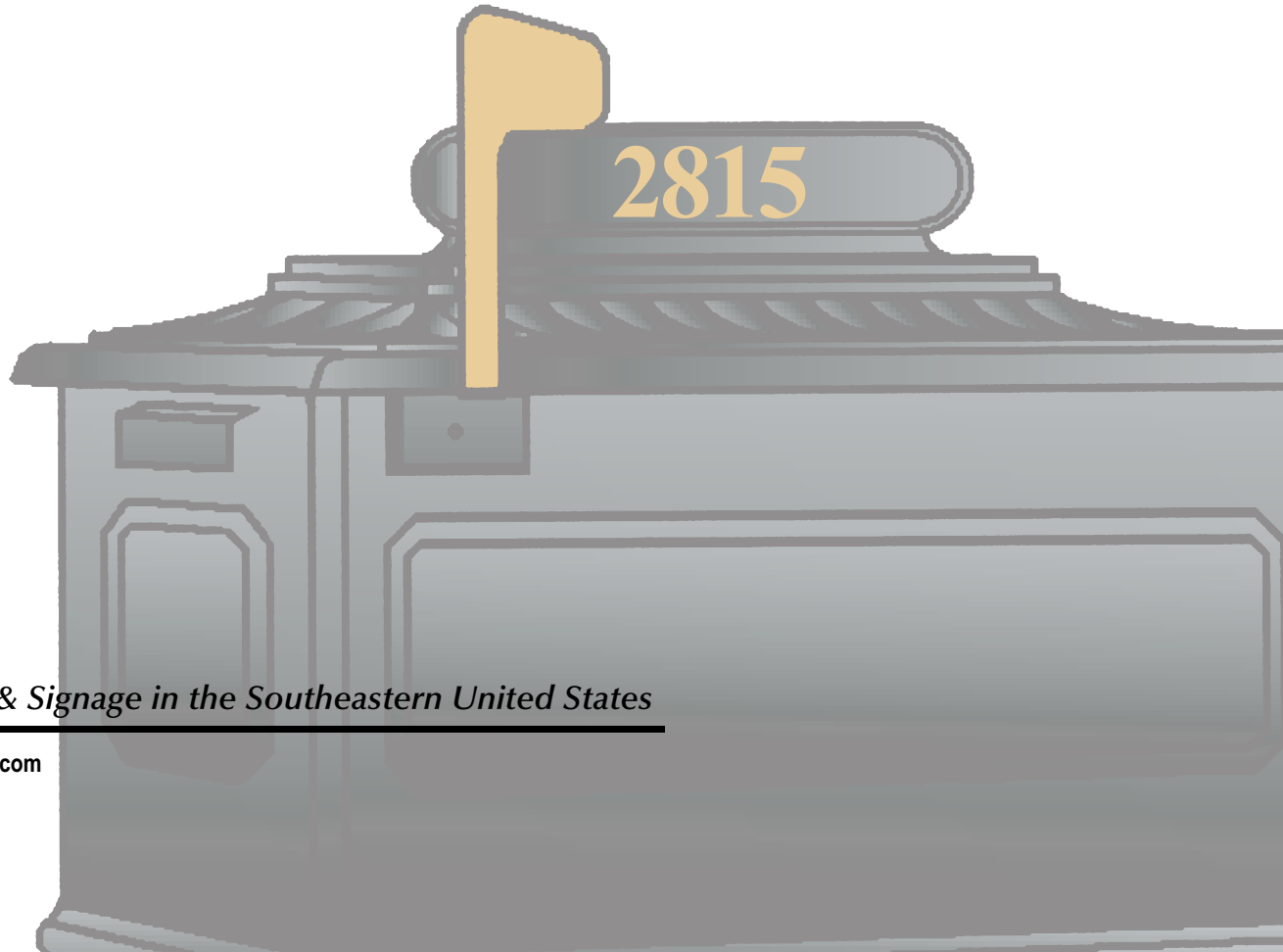

MANOR COLLECTION

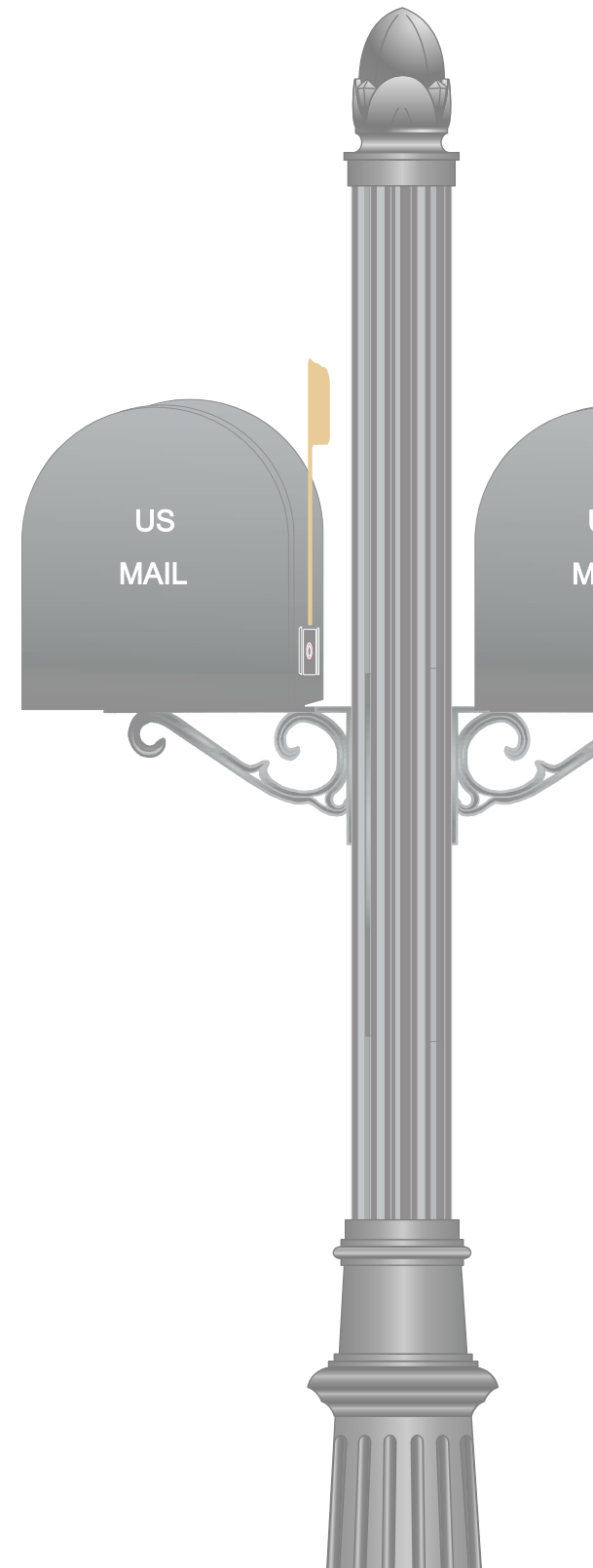

The Leading Manufacturer of Custom Mailboxes & Signage in the Southeastern United States

MANOR COLLECTION

SINGLE



DOUBLE

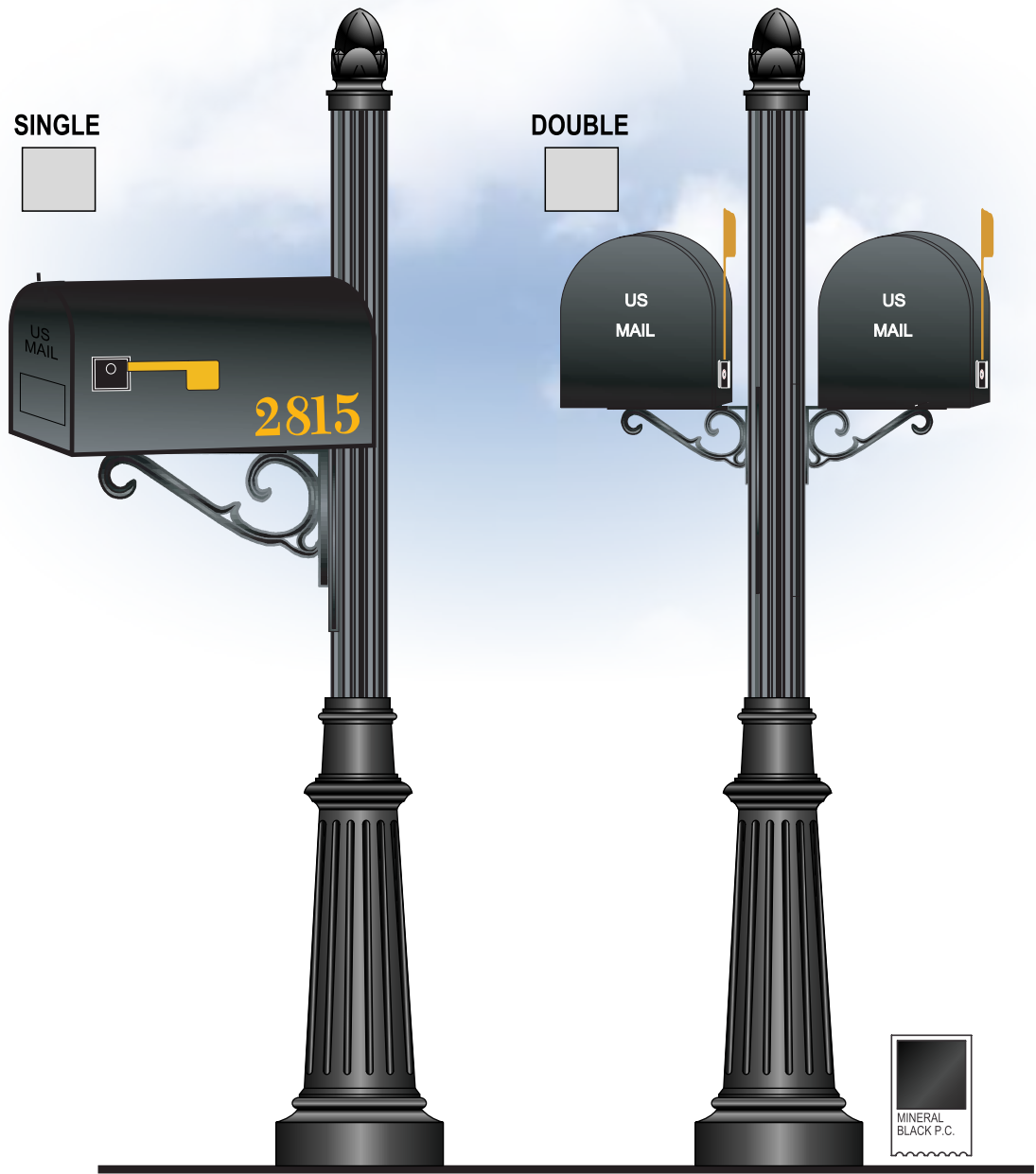

BOX

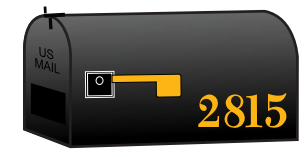

T-1 BLACK



2" NUMBERS ON MAILBOX

NUMBERS ON BRACKETS (see "BRACKET" section)

METALLIC VINYL

REFLECTIVE VINYL

1234567890

FONT: CG CALIFORNIA BOLD
COLOR: GOLD

FLAG



STAMPED- RED



STAMPED- GOLD



FINIAL

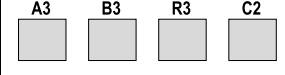
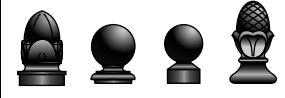

BRACKET



DB12
2 1/2" NUMBERS



DB56
2" NUMBERS



DB21



DB29

POST

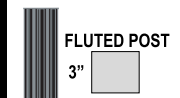

FLUTED POST
3"

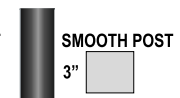

SMOOTH POST
3"

BASE

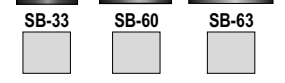
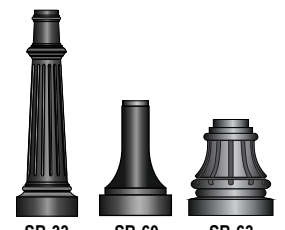

SPECIAL INSTRUCTIONS:

	12801 Commodity Place, Tampa, FL 33626 Phone: 813-818-7100 Fax: 813-749-2311 www.creativesigndesigns.com	PROJECT: _____	CRM / Quote: _____	<input type="checkbox"/> Approved <input type="checkbox"/> Approved as noted <input type="checkbox"/> Revise and resubmit
	This Drawing and all reproductions thereof are the property of Creative Sign Designs and may not be reproduced, published, changed or used in any way without written consent.	SITE ADDRESS: _____	AM: _____	Approved: _____ Date: _____

DESIGN - FABRICATION - INSTALLATION

MANOR COLLECTION

SINGLE



DOUBLE



SPECIAL INSTRUCTIONS:



12801 Commodity Place, Tampa, FL 33626
 Phone: 813-818-7100
 Fax: 813-749-2311
 www.creativesigndesigns.com

This Drawing and all reproductions thereof are the property of Creative Sign Designs and may not be reproduced, published, changed or used in any way without written consent.

PROJECT: _____
 SITE ADDRESS: _____

CRM / Quote: _____
 AM: _____

Approved
 Approved as noted
 Revise and resubmit

Approved: _____
 Date: _____

BOX

T-1 BLACK

2" NUMBERS ON MAILBOX NUMBERS ON BRACKETS
(see "BRACKET" section)

METALLIC VINYL REFLECTIVE VINYL

1234567890

FONT: CG CALIFORNIA BOLD
 COLOR: GOLD

FLAG

STAMPED-RED STAMPED-GOLD

FINIAL

A3 B3 R3 C2

BRACKET

DB12
 2 1/2" NUMBERS

DB56
 2" NUMBERS

DB21 DB29

POST

FLUTED POST 3" SMOOTH POST 3"

BASE

SB-33 SB-60 SB-63

MANOR COLLECTION

SINGLE



DOUBLE

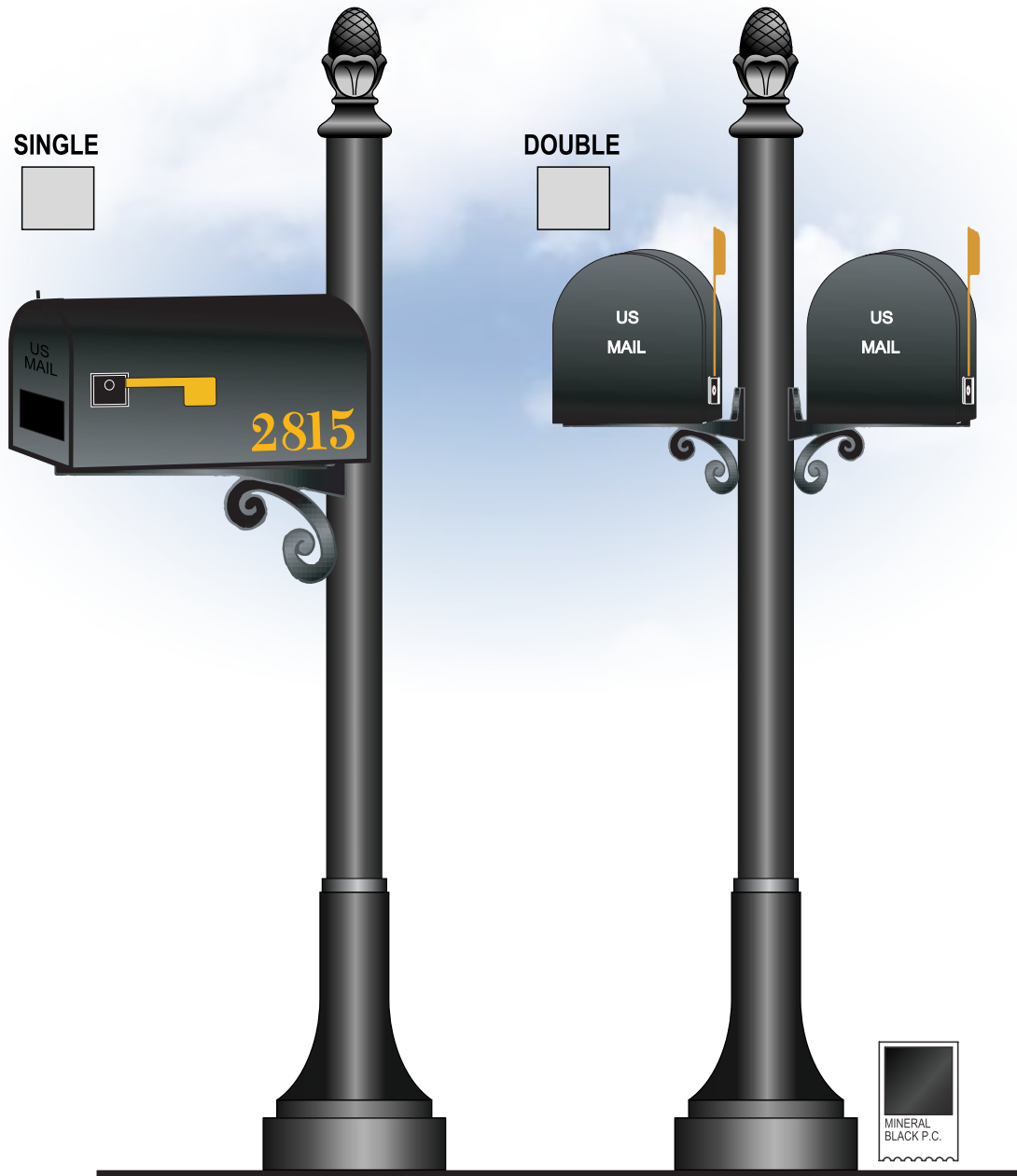

SPECIAL INSTRUCTIONS:

BOX



T-1 BLACK



2" NUMBERS ON MAILBOX



NUMBERS ON BRACKETS

(see "BRACKET" section)



METALLIC VINYL



REFLECTIVE VINYL



1234567890

FONT: CG CALIFORNIA BOLD
COLOR: GOLD

FLAG



STAMPED- RED



STAMPED- GOLD



FINIAL



A3



B3



R3



C2



BRACKET



DB12
2 1/2" NUMBERS



DB56
2" NUMBERS



DB21



DB29



POST



FLUTED POST
3"



SMOOTH POST
3"



BASE



SB-33



SB-60

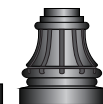

SB-63



12801 Commodity Place, Tampa, FL 33626
Phone: 813-818-7100
Fax: 813-749-2311
www.creativesigndesigns.com

This Drawing and all reproductions thereof are the property of Creative Sign Designs and may not be reproduced, published, changed or used in any way without written consent.

PROJECT:

SITE ADDRESS:

CRM / Quote:

AM:

- Approved
- Approved as noted
- Revise and resubmit

Approved: _____

Date: _____

DESIGN - FABRICATION - INSTALLATION

ESTATE *COLLECTION*

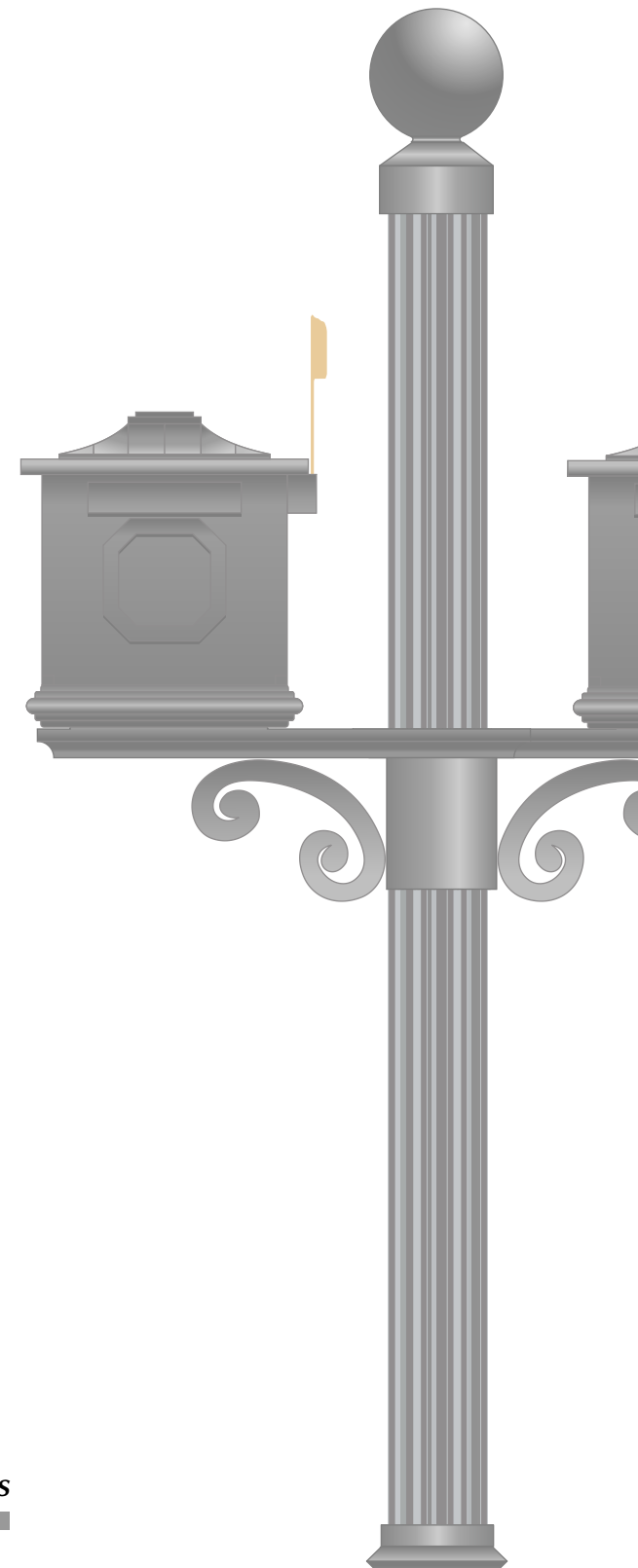

The Leading Manufacturer of Custom Mailboxes & Signage in the Southeastern United States

ESTATE COLLECTION



BOX

ME
(w/ 2" numbers)



NUMBERS ON MAILBOX

NUMBERS ON BRACKETS
(see "BRACKET" section)

ME-1
(w/ 1 1/2" numbers)



METALLIC VINYL

REFLECTIVE VINYL

ME-3
(w/ 2" numbers)



1234567890

FONT: CG CALIFORNIA BOLD
COLOR: GOLD

FLAG



CAST RED



STAMPED RED



CAST GOLD



STAMPED GOLD

FINIAL

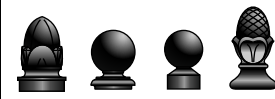

A3 B3 R3 C2

BRACKET



DB24 w/ S Scroll



DB24 w/ C Scroll



DB24 w/ Vine



DB30 Mounting Cap



DB12 2" NUMBERS

POST



FLUTED POST 3"



SMOOTH POST 3"

BASE



SB-73



SB-60



SB-63

SPECIAL INSTRUCTIONS:



12801 Commodity Place, Tampa, FL 33626
Phone: 813-818-7100
Fax: 813-749-2311
www.creativesigndesigns.com

This Drawing and all reproductions thereof are the property of Creative Sign Designs and may not be reproduced, published, changed or used in any way without written consent.

PROJECT: _____
SITE ADDRESS: _____

CRM / Quote: _____
AM: _____

Approved
 Approved as noted
 Revise and resubmit

Approved: _____
Date: _____

DESIGN - FABRICATION - INSTALLATION

ESTATE COLLECTION

SINGLE

DOUBLE

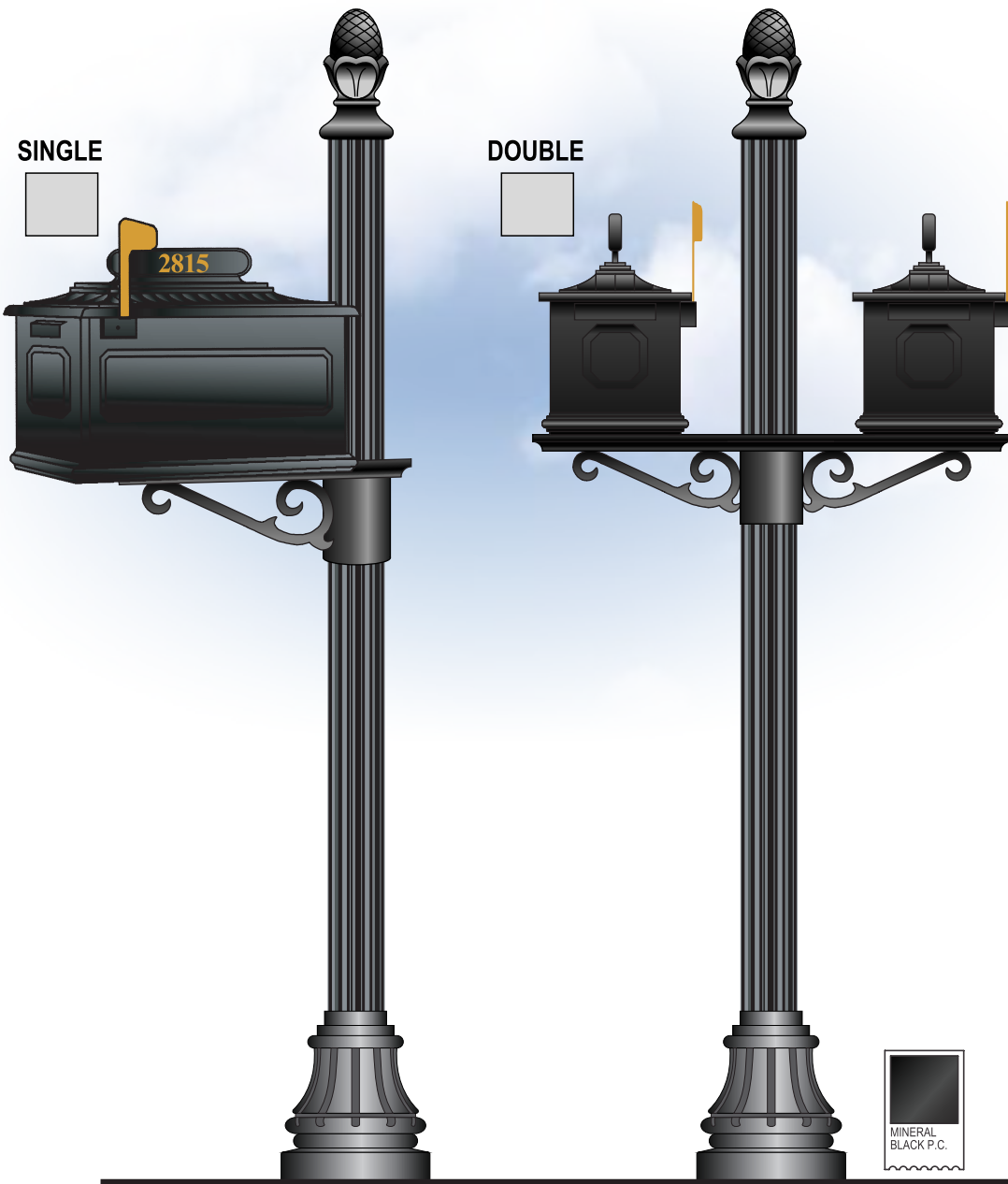

BOX

ME
(w/ 2" numbers)



NUMBERS ON MAILBOX

NUMBERS ON BRACKETS
(see "BRACKET" section)

METALLIC VINYL

REFLECTIVE VINYL

ME-1
(w/ 1 1/2" numbers)



ME-3
(w/ 2" numbers)



1234567890

FONT: CG CALIFORNIA BOLD
COLOR: GOLD

FLAG



CAST RED



STAMPED RED



CAST GOLD



STAMPED GOLD

FINIAL

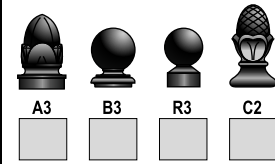

BRACKET



DB24 w/ S Scroll



DB24 w/ C Scroll



DB24 w/ Vine



DB30 Mounting Cap



DB12
2" NUMBERS

POST



FLUTED POST
3"



SMOOTH POST
3"

BASE

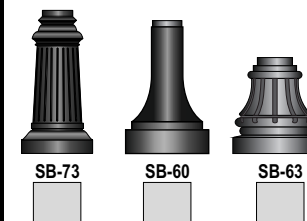

SPECIAL INSTRUCTIONS:



12801 Commodity Place, Tampa, FL 33626
Phone: 813-818-7100
Fax: 813-749-2311
www.creativesignsdesigns.com

This Drawing and all reproductions thereof are the property of Creative Sign Designs and may not be reproduced, published, changed or used in any way without written consent.

PROJECT: _____
SITE ADDRESS: _____

CRM / Quote: _____
AM: _____

Approved
 Approved as noted
 Revise and resubmit
Approved: _____
Date: _____



ESTATE COLLECTION



BOX

ME
(w/ 2" numbers)



NUMBERS ON MAILBOX

NUMBERS ON BRACKETS
(see "BRACKET" section)

ME-1
(w/ 1 1/2" numbers)



METALLIC VINYL

REFLECTIVE VINYL

ME-3
(w/ 2" numbers)



1234567890

FONT: CG CALIFORNIA BOLD
COLOR: GOLD

FLAG



CAST RED



STAMPED RED



CAST GOLD



STAMPED GOLD

FINIAL



A3



B3



R3



C2

BRACKET



DB24 w/ S Scroll



DB24 w/ C Scroll



DB24 w/ Vine



DB30 Mounting Cap



DB12 2" NUMBERS

POST



FLUTED POST
3"



SMOOTH POST
3"

BASE



SB-73



SB-60



SB-63

SPECIAL INSTRUCTIONS:



12801 Commodity Place, Tampa, FL 33626
Phone: 813-818-7100
Fax: 813-749-2311
www.creativesignsdesigns.com

This Drawing and all reproductions thereof are the property of Creative Sign Designs and may not be reproduced, published, changed or used in any way without written consent.

PROJECT: _____
SITE ADDRESS: _____

CRM / Quote: _____
AM: _____

Approved
 Approved as noted
 Revise and resubmit
Approved: _____
Date: _____

ROYAL COLLECTION



The Leading Manufacturer of Custom Mailboxes & Signage in the Southeastern United States

ROYAL COLLECTION

SINGLE



DOUBLE



BOX

ME-4
(w/ 2" numbers)



NUMBERS ON MAILBOX

NUMBERS ON BRACKETS
(see "BRACKET" section)

ME-5
(w/ 2" numbers)



METALLIC VINYL

REFLECTIVE VINYL

ME-6
(w/ 1 1/2" numbers)



1234567890

FONT: CG CALIFORNIA BOLD
COLOR: GOLD

FLAG



CAST RED



STAMPED RED



CAST GOLD



STAMPED GOLD



FINIAL



A3



B3



R3



C2



BRACKET



DB24 w/ S Scroll



DB12
2" NUMBERS



DB24 w/ Vine



DB30 Mounting Cap

POST

FLUTED POST

3"



SMOOTH POST

3"



BASE



SB-33



SB-36



2PC-3



SPECIAL INSTRUCTIONS:



12801 Commodity Place, Tampa, FL 33626
Phone: 813-818-7100
Fax: 813-749-2311
www.creativesigndesigns.com

This Drawing and all reproductions thereof are the property of Creative Sign Designs and may not be reproduced, published, changed or used in any way without written consent.

PROJECT:

SITE ADDRESS:

CRM / Quote:

AM:

- Approved
- Approved as noted
- Revise and resubmit

Approved: _____

Date: _____

ROYAL COLLECTION

SINGLE

DOUBLE

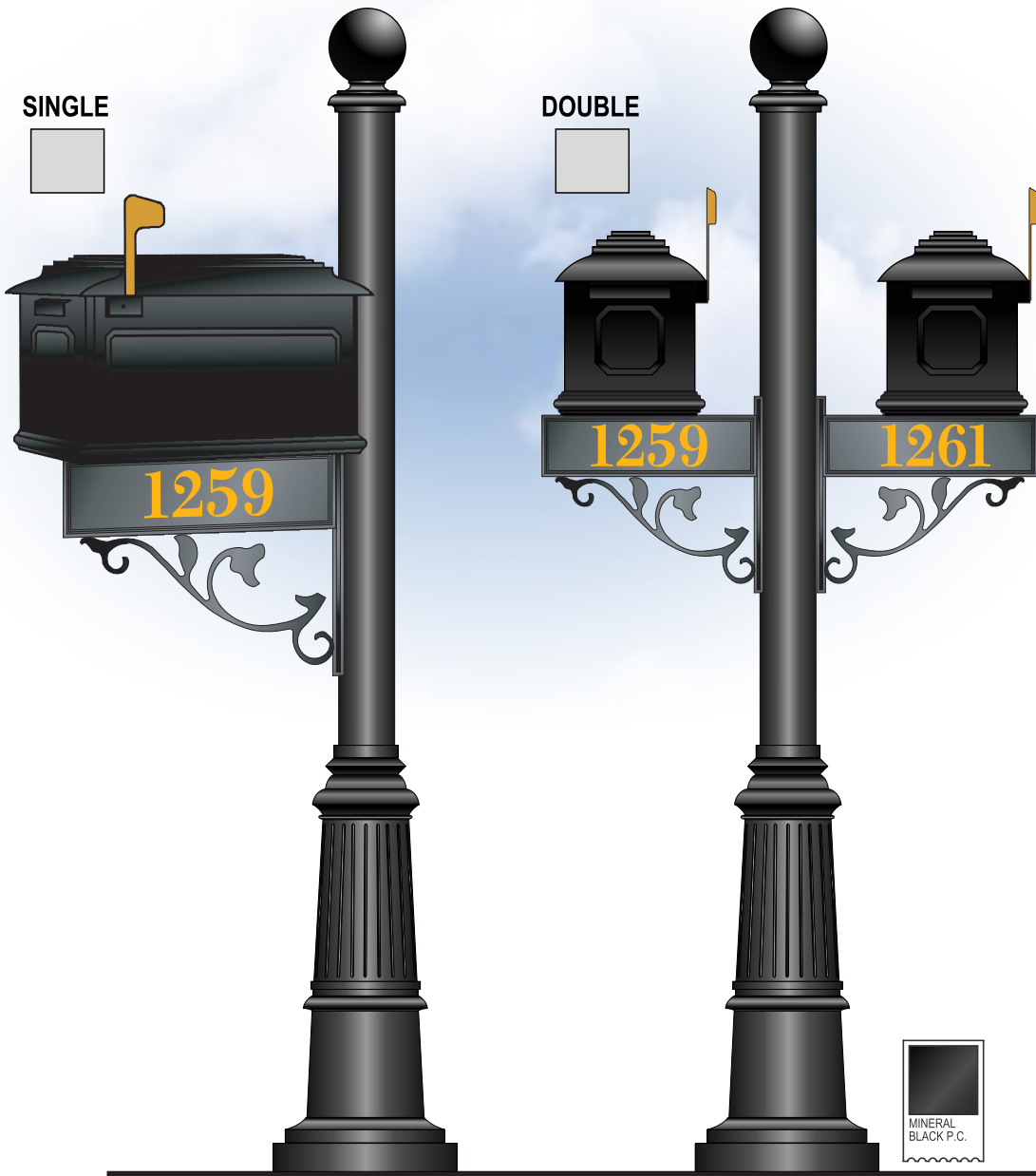

BOX

ME-4
(w/ 2" numbers)



NUMBERS ON MAILBOX

NUMBERS ON BRACKETS
(see "BRACKET" section)

ME-5
(w/ 2" numbers)



METALLIC VINYL

REFLECTIVE VINYL

ME-6
(w/ 1 1/2" numbers)



1234567890

FONT: CG CALIFORNIA BOLD
COLOR: GOLD

FLAG



CAST RED



STAMPED RED



CAST GOLD



STAMPED GOLD

FINIAL



A3



B3



R3



C2

BRACKET



DB24 w/ S Scroll



DB24 w/ Vine



DB12
2" NUMBERS



DB30 Mounting Cap

POST



FLUTED POST
3"



SMOOTH POST
3"

BASE



SB-33

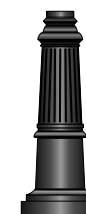

SB-36



2PC-3

SPECIAL INSTRUCTIONS:



12801 Commodity Place, Tampa, FL 33626
Phone: 813-818-7100
Fax: 813-749-2311
www.creativesigndesigns.com

This Drawing and all reproductions thereof are the property of Creative Sign Designs and may not be reproduced, published, changed or used in any way without written consent.

PROJECT: _____
SITE ADDRESS: _____

CRM / Quote: _____
AM: _____

Approved
 Approved as noted
 Revise and resubmit
Approved: _____
Date: _____

ROYAL COLLECTION

SINGLE

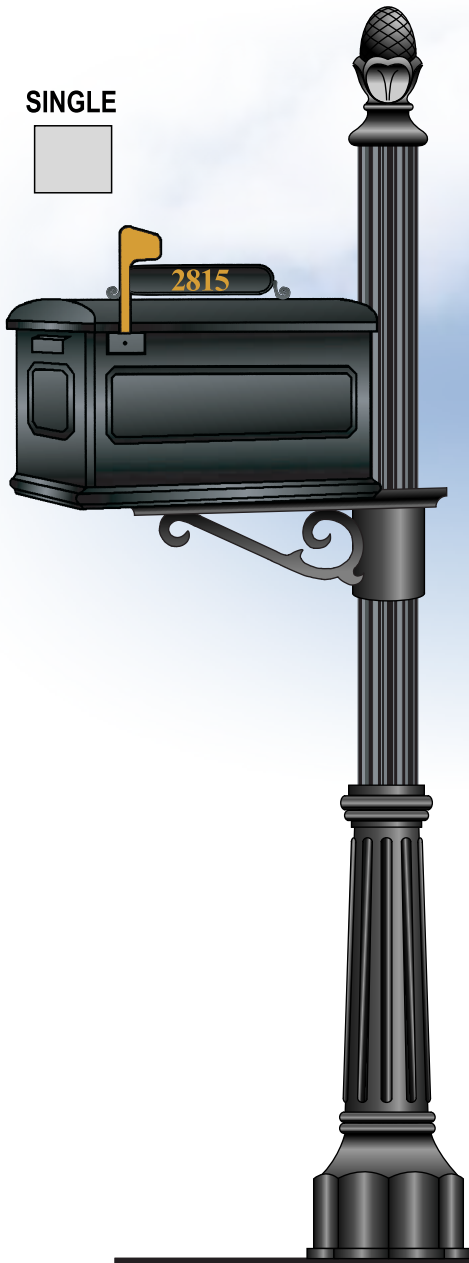

DOUBLE

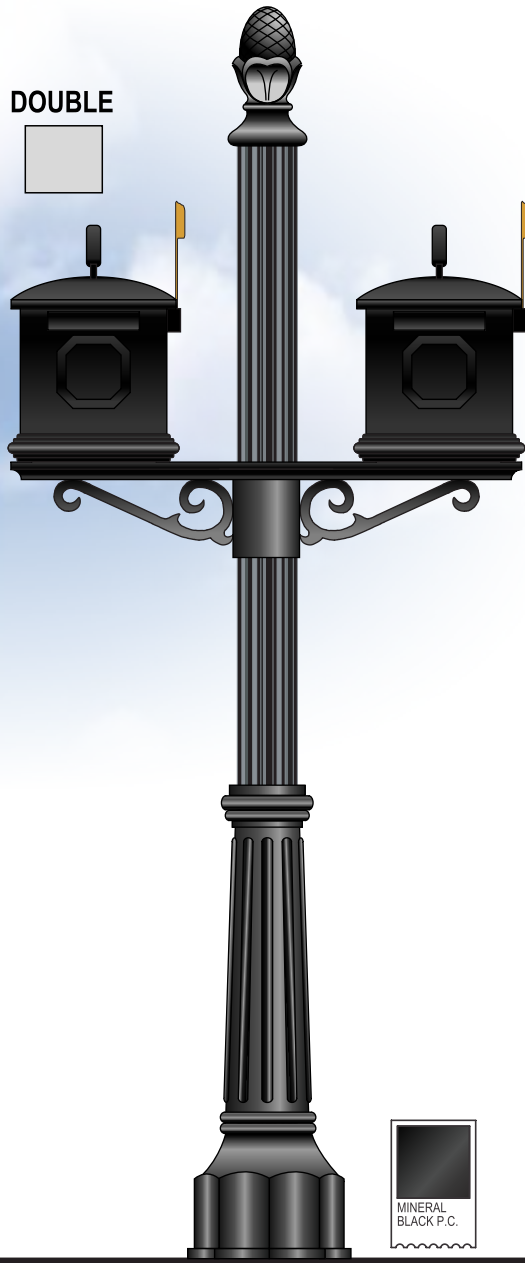

BOX

ME-4
(w/ 2" numbers)



NUMBERS ON MAILBOX

NUMBERS ON BRACKETS
(see "BRACKET" section)

ME-5
(w/ 2" numbers)



METALLIC VINYL

REFLECTIVE VINYL

ME-6
(w/ 1 1/2" numbers)



1234567890

FONT: CG CALIFORNIA BOLD
COLOR: GOLD

FLAG



CAST RED



STAMPED RED



CAST GOLD



STAMPED GOLD

FINIAL



A3



B3



R3



C2

BRACKET



DB24 w/ S Scroll



DB24 w/ Vine



DB12
2" NUMBERS



DB30 Mounting Cap

POST



FLUTED POST
3"



SMOOTH POST
3"

BASE



SB-33



SB-36



2PC-3

SPECIAL INSTRUCTIONS:



12801 Commodity Place, Tampa, FL 33626
Phone: 813-818-7100
Fax: 813-749-2311
www.creativesigndesigns.com

This Drawing and all reproductions thereof are the property of Creative Sign Designs and may not be reproduced, published, changed or used in any way without written consent.

PROJECT:

SITE ADDRESS:

CRM / Quote:

AM:

- Approved
- Approved as noted
- Revise and resubmit

Approved: _____

Date: _____

DESIGN - FABRICATION - INSTALLATION

CLASSIC COLLECTION

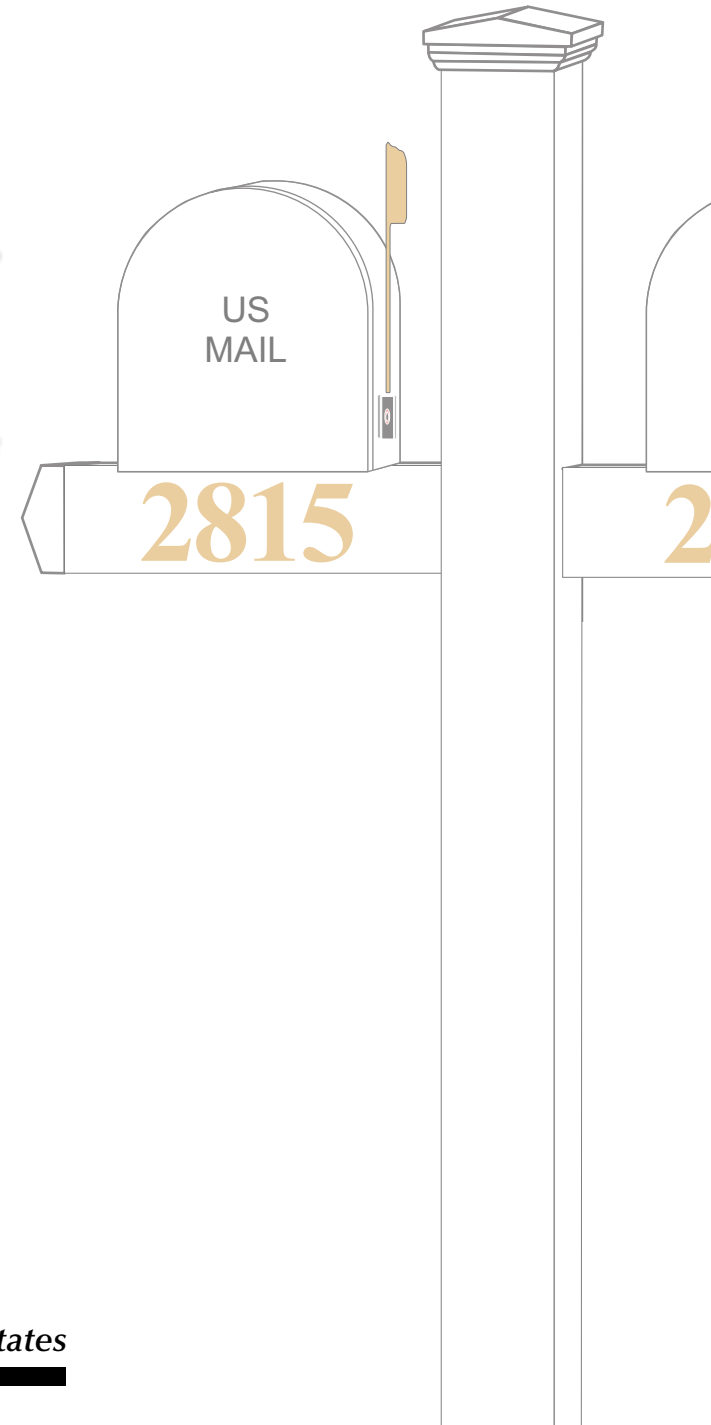

The Leading Manufacturer of Custom Mailboxes & Signage in the Southeastern United States

CLASSIC COLLECTION

SINGLE

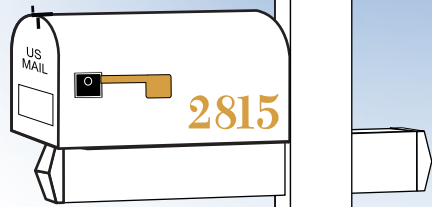

DOUBLE

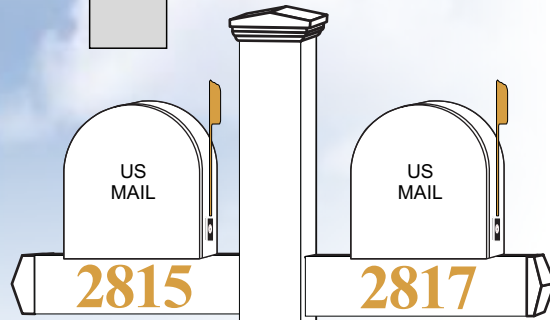

BOX

T-1 WHITE

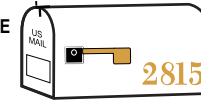

2" NUMBERS ON MAILBOX



NUMBERS ON BRACKETS



T-1 BLACK



METALLIC VINYL



REFLECTIVE VINYL



1234567890

FONT: CG CALIFORNIA BOLD
COLOR: GOLD

FLAG



STAMPED- GOLD



STAMPED- RED



FINIAL



GOthic



NEW ENGLAND



POST



TAN



WHITE



SPECIAL INSTRUCTIONS:



12801 Commodity Place, Tampa, FL 33626
Phone: 813-818-7100
Fax: 813-749-2311
www.creativesigndesigns.com

This Drawing and all reproductions thereof are the property of Creative Sign Designs and may not be reproduced, published, changed or used in any way without written consent.

PROJECT:

SITE ADDRESS:

CRM / Quote:

AM:

- Approved
- Approved as noted
- Revise and resubmit

Approved: _____

Date: _____

DESIGN - FABRICATION - INSTALLATION



DESIGN - FABRICATION - INSTALLATION

Creative Mailbox Designs, LLC Service Agreement

Creative Mailbox Designs, LLC commits to install this product within 4 weeks of customer approval and receipt of an approved plan from the U.S. Postal Service. If an approved site plan is not received, any orders called in will be processed, however, the customer will be responsible for any relocation charge mandated by the U.S. Postal Service. We will accommodate requests for earlier product installation and/or installation of temporary mailboxes but these requests may be subject to a minimum trip charge of \$50.

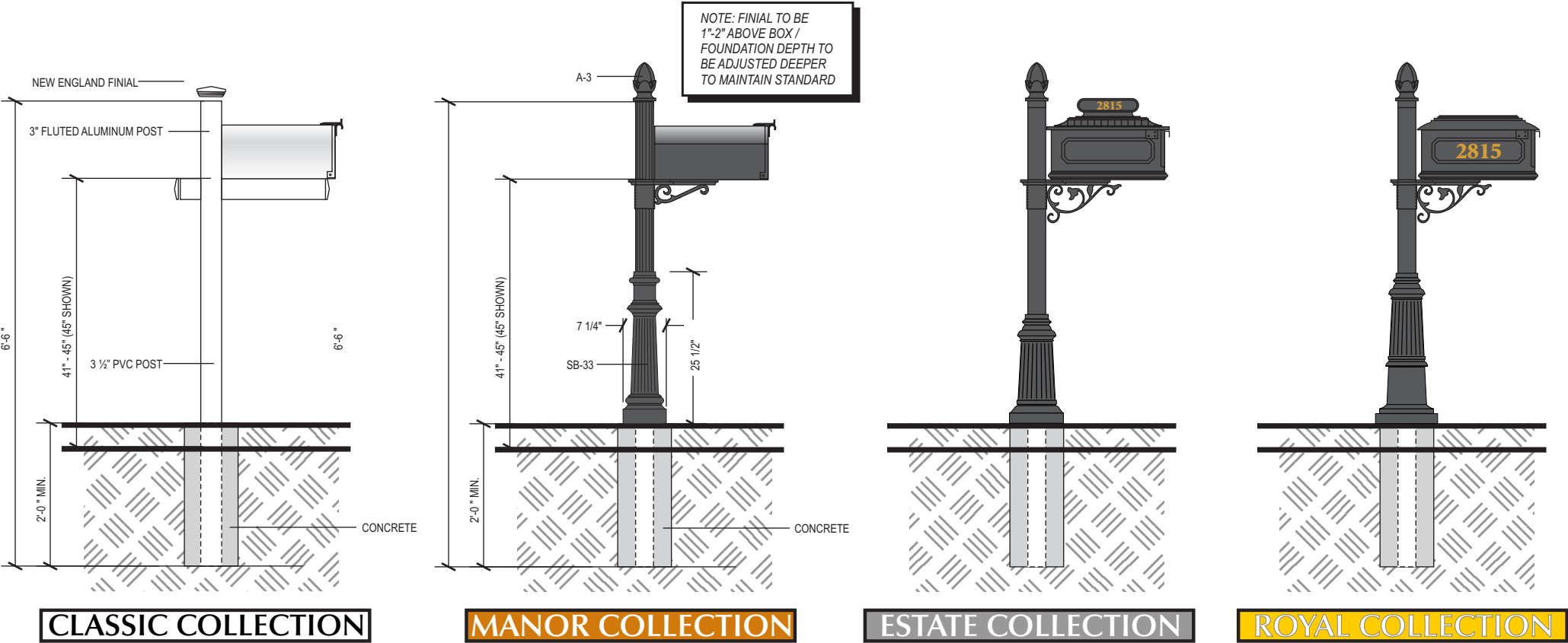

CLASSIC COLLECTION

MANOR COLLECTION

ESTATE COLLECTION

ROYAL COLLECTION

2" **2815**

ALL COMPONENTS
POWDER COAT
MINERAL BLACK

REFLECTIVE / GOLD VINYL LETTERS
3M 5100-64

FONT: CG CALIFORNIA BOLD